



MOTOR MODEL:	BL3-AL-TF-80B3-4-B-D-1
FACTORY TYPE:	-

ELECTRICAL DATA		
	60 Hz	50 Hz
Horsepower	-	-
Speed, RPM	-	-
Voltage	-	-
# Phase	-	-
Full Load Amps	-	-
Power Factor	-	-
Nominal Efficiency	-	-
3/4 Load Efficiency	-	-
Service Factor	-	-
KVA Code	-	-
FL Amps. @ 208 V	-	-
LRC @ 60Hz HV	-	-
Start Capacitor	-	-
Start Capacitor V	-	-
Run Capacitor	-	-
Run Capacitor V	-	-
Number of Leads	-	-
Connection	-	-
Coil Resistance	-	-
Date Code	-	-
Load	Efficiency %	P.F.
50%	-	-
75%	-	-
100%	-	-
FULL LOAD TEMPERATURE RISE		
FL Temp Rise °C	-	-
3D Image Link		
Not available for this motor		

GENERAL DATA		
Frame Size	-	-
Frame Enclosure	-	-
Mounting	-	-
Insulation Class	-	-
Duty	-	-
NEMA Design	-	-
Frame Material	-	-
Ingress Protection	-	-
Tropicalization	-	-
Cable Entry	-	-
Feet Removable	-	-
Double Drilled	-	-
Paint Color	-	-
Paint RAL	-	-
Weight lb	-	-
MECHANICAL DATA		
DE Bearing	-	-
NDE Bearing	-	-
dB No-Load	-	-
Rotor Wk ² , Lb-Ft ²	-	-
Comp Ring (wavey washer)	-	-
TORQUE VALUES	Torque lb-ft	% FLT
Locked Rotor Torque	-	-
Pull-Up Torque	-	-
Breakdown Torque	-	-
Full Load Torque	-	-
SITE CONDITIONS		
Ambient Temp °C	-	-
Altitude Above Sea Level m	-	-

*This report valid for above Date Code and newer models, please contact Techttop for more info.

Techtop Industries
 2815 Colonnades Court
 Peachtree Corners, GA 30071
 Tel: 678-436-5540
 E-Mail: info@techttopind.com



MOTOR MODEL:	BL3-AL-TF-80B3-4-B-D-1
FACTORY TYPE:	-

Torque Speed (T-n) Curve

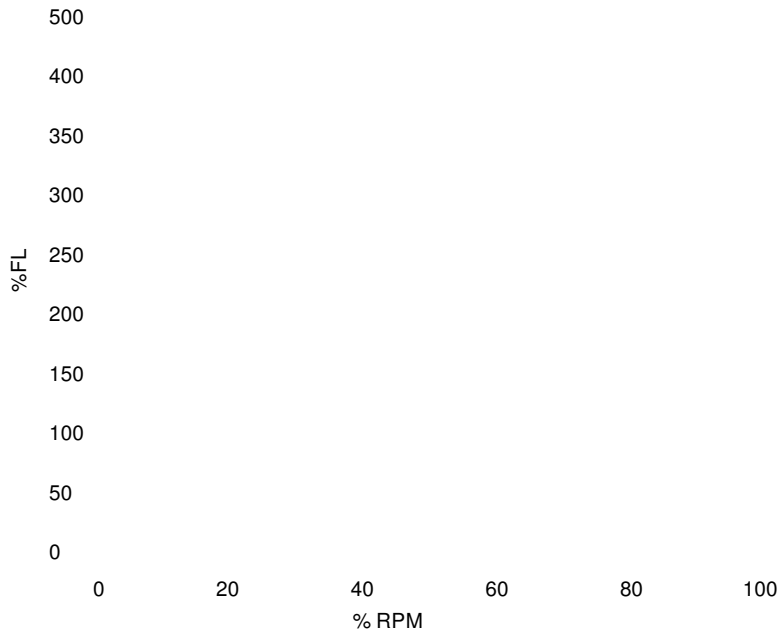

Performance Load Values, High Voltage, 60Hz

Torque Values	Torque lb-ft	% FLT	Performance Values
Locked Rotor Torque	-	-	Start Configuration
Pull-Up Torque	-	-	Starting Current (A)
Breakdown Torque	-	-	No-Load Current (A)
Full Load	-	-	No-Load Power Factor

% Load	Horsepower	Current, Amps	Input power, Kilowatts	Speed, RPM	Efficiency	PF
0	-	-	-	-	-	-
25	-	-	-	-	-	-
50	-	-	-	-	-	-
75	-	-	-	-	-	-
100	-	-	-	-	-	-
125	-	-	-	-	-	-