



NEMA Premium

NEMA

MOTOR MODEL:	BR3-CI-TF-326TC-6-BR-E-30
FACTORY TYPE:	TXC

Premium NEMA Cast Iron, TEFC

Non Sinusoidal (VFD) Output 30.0HP, 1180 RPM

Torque Speed (T-n) Curve

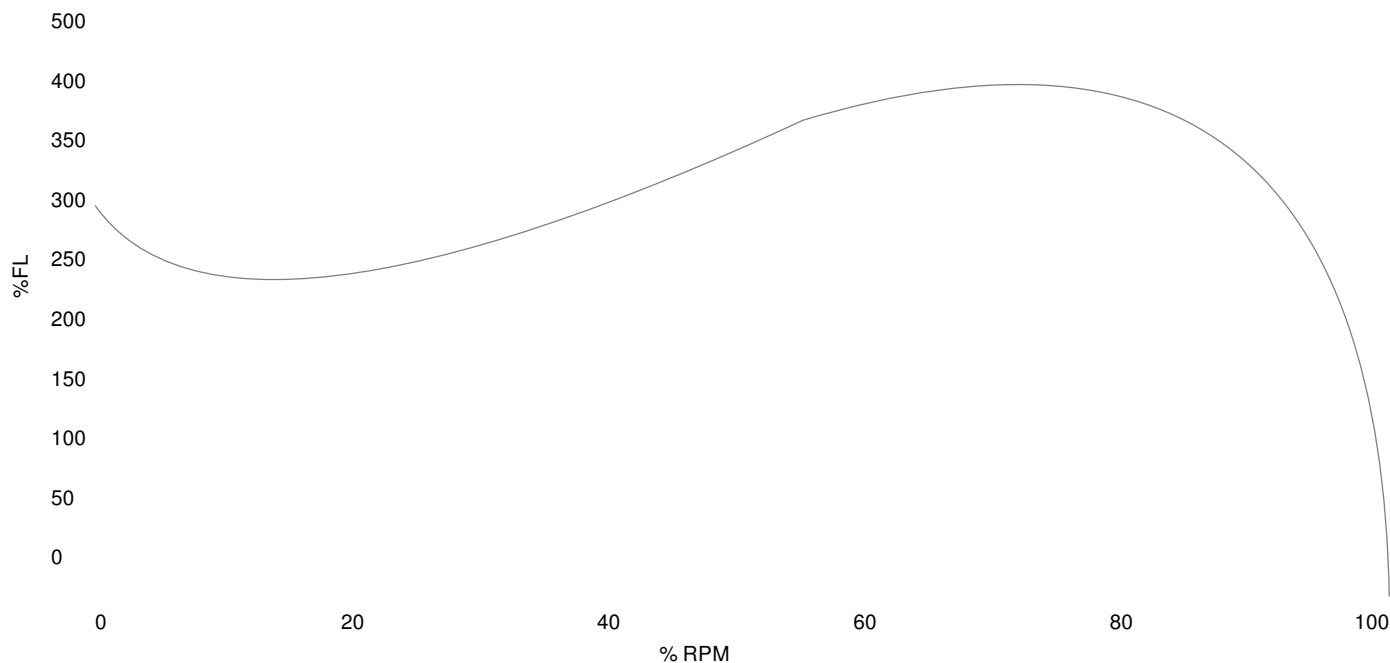

Performance Load Values, High Voltage, 60Hz

Torque Values	Torque lb-ft	% FLT	Performance Values
Locked Rotor Torque	406.285	302.0	Start Configuration
Pull-Up Torque	216.595	161.0	Starting Current (A)
Breakdown Torque	495.075	368.0	No-Load Current (A)
Full Load	134.531	100.0	No-Load Power Factor

% Load	Horsepower	Current, Amps	Input power, Kilowatts	Speed, RPM	Efficiency	PF
0	-	17.02	-	-	-	-
25	7.5	18.23	6.31	1196.0	88.29	0.43
50	15.0	23.42	12.07	1192.5	92.38	0.65
75	22.5	29.7	17.94	1188.6	93.22	0.76
100	30.0	36.9	23.95	1184.5	93.12	0.81
125	37.5	44.85	30.1	1179.9	92.6	0.84

Techtop Industries
 2815 Colonnades Court
 Peachtree Corners, GA 30071
 Tel: 678-436-5540
 E-Mail: info@techttopind.com