



NEMA Premium

NEMA

MOTOR MODEL:	BR3-CI-TF-365T-6-BR-E-50
FACTORY TYPE:	TXC

Premium NEMA Cast Iron, TEFC

ELECTRICAL DATA		
	60 Hz	50 Hz
Horsepower	50.0	50.0
Speed, RPM	1180	980
Voltage	460	380
# Phase	3	
Full Load Amps	59.2	-
Power Factor	0.84	-
Nominal Efficiency	94.1	92.5
3/4 Load Efficiency	-	-
Service Factor	1.15	1.0
KVA Code	H	E
FL Amps. @ 208 V	-	-
Locked Rotor Current	550.05	-
Start Capacitor	-	
Start Capacitor V	-	
Run Capacitor	-	
Run Capacitor V	-	
Number of Leads	12	
Connection	DD/D	
Coil Resistance	-	
Date Code	-	
Load	Efficiency %	P.F.
50%	93.37	0.72
75%	94.14	0.82
100%	94.07	0.86
FULL LOAD TEMPERATURE RISE		
FL Temp Rise °C	66.0	-
3D Image Link		
BR3-CI-TF-365T-6-BR-E-50		

GENERAL DATA			
Frame Size	365T		
Frame Enclosure	TEFC		
Mounting	Rigid		
Insulation Class	F		
Duty	Cont. / S1		
NEMA Design	A		
Frame Material	Cast Iron		
Ingress Protection	56		
Tropicalization	true		
Cable Entry	1-NPT 2"		
Feet Removable	-		
Double Drilled	true		
Paint Color	Graphite Gray		
Paint RAL	7024		
Weight lb	791.595		
MECHANICAL DATA			
DE Bearing	6313C3		
NDE Bearing	6313C3		
dB No-Load	-		
Rotor Wk ² , Lb-Ft ²	-		
Comp Ring (wavey washer)	DE		
TORQUE VALUES		Torque lb-ft	% FLT
Locked Rotor Torque	668.461	301.0	
Pull-Up Torque	406.406	183.0	
Breakdown Torque	708.435	319.0	
Full Load Torque	222.08	100.0	
SITE CONDITIONS			
Ambient Temp °C	40		
Altitude Above Sea Level m	1000		



NEMA Premium

NEMA

MOTOR MODEL:	BR3-CI-TF-365T-6-BR-E-50
FACTORY TYPE:	TXC

Premium NEMA Cast Iron, TEFC

Non Sinusoidal (VFD) Output 50.0HP, 1180 RPM

Torque Speed (T-n) Curve

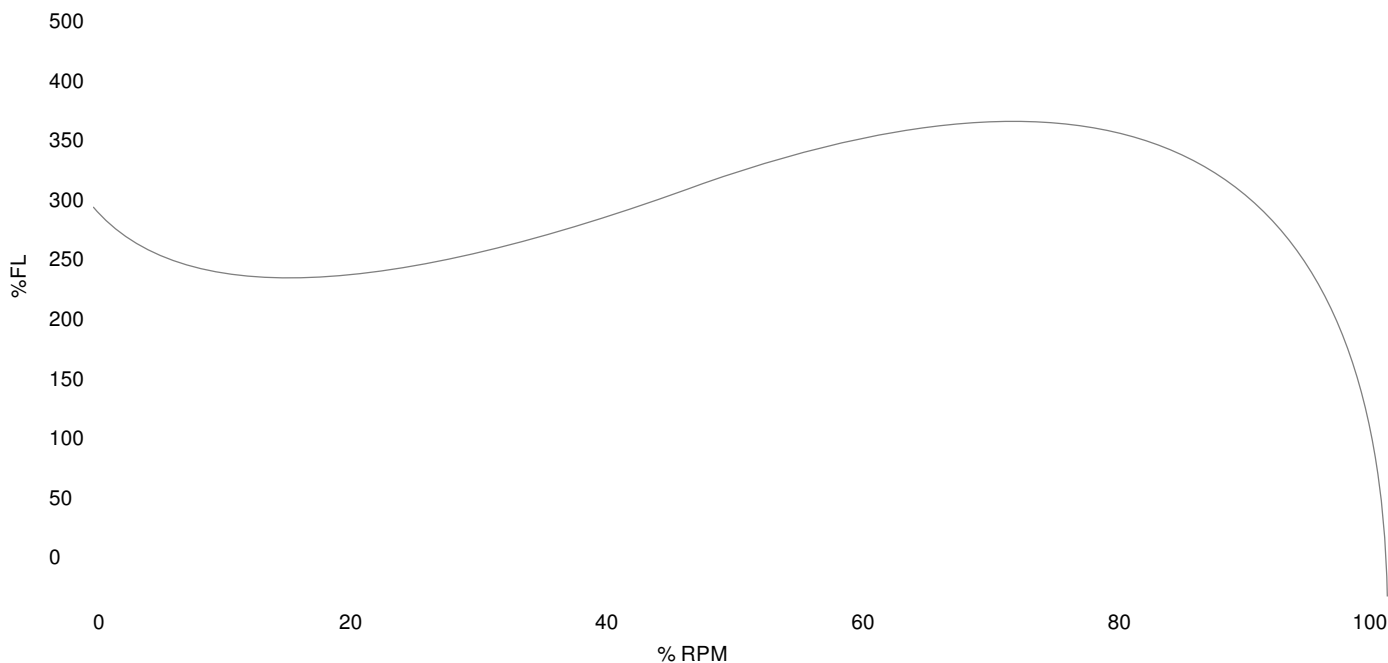

Performance Load Values, High Voltage, 60Hz

Torque Values	Torque lb-ft	% FLT	Performance Values
Locked Rotor Torque	668.461	301.0	Start Configuration
Pull-Up Torque	406.406	183.0	Starting Current (A)
Breakdown Torque	708.435	319.0	No-Load Current (A)
Full Load	222.08	100.0	No-Load Power Factor

% Load	Horsepower	Current, Amps	Input power, Kilowatts	Speed, RPM	Efficiency	PF
0	-	22.36	-	-	-	-
25	12.5	25.93	10.41	1196.8	89.62	0.5
50	25.0	34.69	19.98	1193.9	93.37	0.72
75	37.5	45.51	29.72	1190.7	94.14	0.82
100	50.0	57.9	39.65	1187.3	94.07	0.86
125	62.5	71.36	49.8	1183.7	93.63	0.88

Techtop Industries
 2815 Colonnades Court
 Peachtree Corners, GA 30071
 Tel: 678-436-5540
 E-Mail: info@techttopind.com