



NEMA Premium

NEMA

MOTOR MODEL:	BR3-CI-TF-365TC-6-BR-E-50
FACTORY TYPE:	TXC

Premium NEMA Cast Iron, TEFC

ELECTRICAL DATA		
	60 Hz	50 Hz
Horsepower	50.0	50.0
Speed, RPM	1180	980
Voltage	460	380
# Phase	3	
Full Load Amps	59.2	-
Power Factor	0.84	-
Nominal Efficiency	94.1	92.5
3/4 Load Efficiency	-	-
Service Factor	1.15	1.0
KVA Code	H	E
FL Amps. @ 208 V	-	-
Locked Rotor Current	550.05	-
Start Capacitor	-	
Start Capacitor V	-	
Run Capacitor	-	
Run Capacitor V	-	
Number of Leads	12	
Connection	DD/D	
Coil Resistance	-	
Date Code	-	
Load	Efficiency %	P.F.
50%	93.37	0.72
75%	94.14	0.82
100%	94.07	0.86
FULL LOAD TEMPERATURE RISE		
FL Temp Rise °C	66.0	-
3D Image Link		
Not available for this motor		

GENERAL DATA		
Frame Size	365TC	
Frame Enclosure	TEFC	
Mounting	Rigid/C-Flange	
Insulation Class	F	
Duty	Cont. / S1	
NEMA Design	A	
Frame Material	Cast Iron	
Ingress Protection	56	
Tropicalization	true	
Cable Entry	1-NPT 2"	
Feet Removable	-	
Double Drilled	true	
Paint Color	Graphite Gray	
Paint RAL	7024	
Weight lb	791.595	
MECHANICAL DATA		
DE Bearing	6313C3	
NDE Bearing	6313C3	
dB No-Load	-	
Rotor Wk ² , Lb-Ft ²	-	
Comp Ring (wavey washer)	-	
TORQUE VALUES		% FLT
Locked Rotor Torque	668.461	301.0
Pull-Up Torque	406.406	183.0
Breakdown Torque	708.435	319.0
Full Load Torque	222.08	100.0
SITE CONDITIONS		
Ambient Temp °C	40	
Altitude Above Sea Level m	1000	



NEMA Premium

NEMA

MOTOR MODEL:	BR3-CI-TF-365TC-6-BR-E-50
FACTORY TYPE:	TXC

Premium NEMA Cast Iron, TEFC

Non Sinusoidal (VFD) Output 50.0HP, 1180 RPM

Torque Speed (T-n) Curve

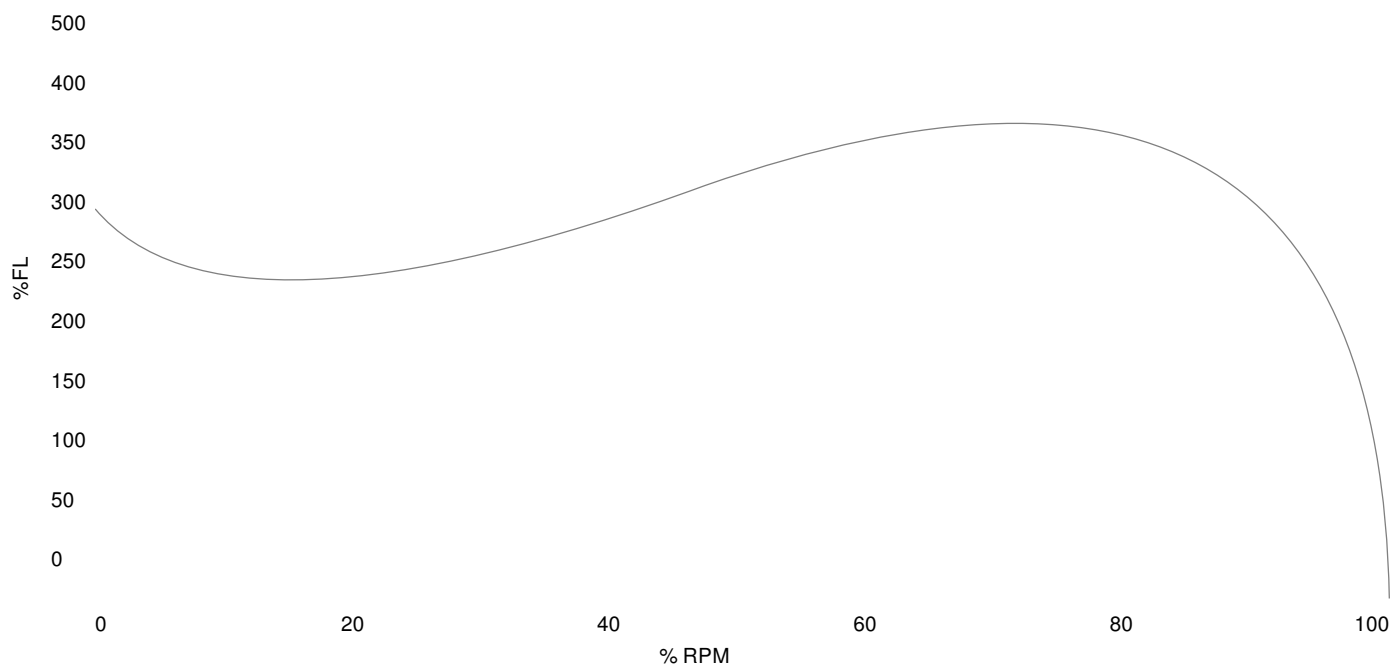

Performance Load Values, High Voltage, 60Hz

Torque Values	Torque lb-ft	% FLT	Performance Values
Locked Rotor Torque	668.461	301.0	Start Configuration
Pull-Up Torque	406.406	183.0	Starting Current (A)
Breakdown Torque	708.435	319.0	No-Load Current (A)
Full Load	222.08	100.0	No-Load Power Factor

% Load	Horsepower	Current, Amps	Input power, Kilowatts	Speed, RPM	Efficiency	PF
0	-	22.36	-	-	-	-
25	12.5	25.93	10.41	1196.8	89.62	0.5
50	25.0	34.69	19.98	1193.9	93.37	0.72
75	37.5	45.51	29.72	1190.7	94.14	0.82
100	50.0	57.9	39.65	1187.3	94.07	0.86
125	62.5	71.36	49.8	1183.7	93.63	0.88

Techtop Industries
 2815 Colonnades Court
 Peachtree Corners, GA 30071
 Tel: 678-436-5540
 E-Mail: info@techttopind.com