



NEMA Premium

MOTOR MODEL:	BR3-CI-TF-445TC-4-BR-E-150
FACTORY TYPE:	TXC

NEMA

Premium NEMA Cast Iron, TEFC

Non Sinusoidal (VFD) Output 150.0HP, 1780 RPM

Torque Speed (T-n) Curve

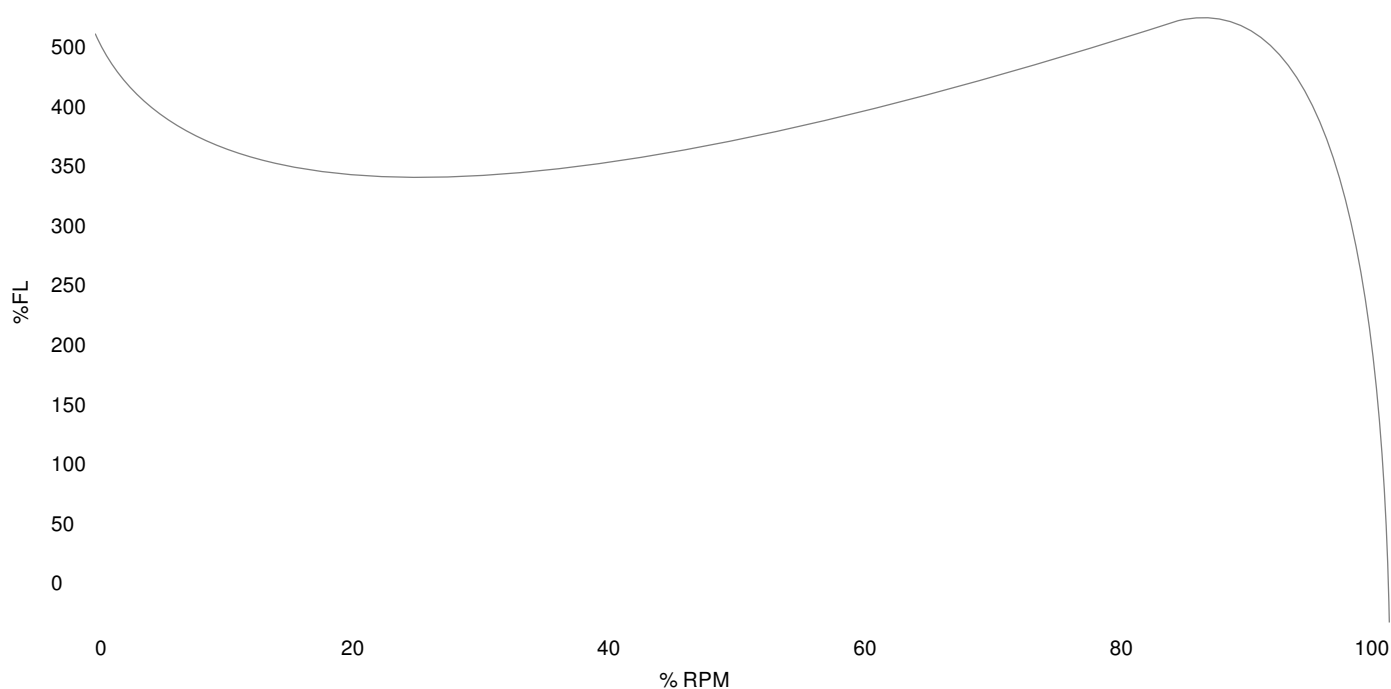

Performance Load Values, High Voltage, 60Hz

Torque Values	Torque lb-ft	% FLT	Performance Values	
Locked Rotor Torque	1962.2	455.0	Start Configuration	-
Pull-Up Torque	983.256	228.0	Starting Current (A)	-
Breakdown Torque	2005.32	465.0	No-Load Current (A)	-
Full Load	431.253	100.0	No-Load Power Factor	-

% Load	Horsepower	Current, Amps	Input power, Kilowatts	Speed, RPM	Efficiency	PF
0	-	65.07	-	-	-	-
25	37.5	78.63	34.53	1797.4	91.59	0.55
50	75.0	109.21	66.75	1794.9	94.76	0.77
75	112.5	146.37	99.37	1792.3	95.48	0.85
100	150.0	187.92	132.44	1789.6	95.52	0.88
125	187.5	214.06	152.51	1787.9	95.39	0.89

Techtop Industries
 2815 Colonnades Court
 Peachtree Corners, GA 30071
 Tel: 678-436-5540
 E-Mail: info@techttopind.com