

Techtop Industries Nameplate and Performance Data

NAMEPLATE DATA		
	60 Hz.	50 Hz.
Horsepower	3.0	3.0
Frame Size	145JM	
Speed, RPM	3490	-
Voltage	3 Phase US (575V)	-
# Phase	3	
Full Load Amps	3.11	-
Power Factor	0.83	-
Nominal Efficiency	85.5	-
3/4 Load Efficiency	-	-
Service Factor	1.25	-
Duty	Cont. / S1	
FL Temp Rise °C	38.0	-
Enclosure	TEFC	
Ambient Temp °C	40	
KVA Code	L	-
FL Amps. @ 208 V	-	-
Insulation Class	F	
NEMA Design	A	
Weight	50.0	
DE Bearing	6206ZZ	
NDE Bearing	6205ZZ	
dB No-Load	-	
Rotor Wk ² , Lb-Ft ²	-	
Start Capacitor		
Start Capacitor V		
Run Capacitor		
Run Capacitor V		
Number of Leads	3	
Connection	Y	
Coil Resistance	-	

Motor Model:	GA3-AL-TF-145JM-2-B-F-3
---------------------	--------------------------------

Performance Load Values:

% Load	Horsepower	Current, Amps	Input power, Kilowatts	Speed, RPM	Efficiency	PF
0	-	-	-	-	-	-
25	-	-	-	-	-	-
50	-	-	-	-	-	-
75	-	-	-	-	-	-
100	-	-	-	-	-	-
125	-	-	-	-	-	-
150	-	-	-	-	-	-
SF	-	-	-	-	-	-

	Torque, Lb-Ft	% Full Load Torque	Speed, RPM	Current Amps.
Locked Rotor Torque	-	-	-	-
Pull Up Torque	-	-	-	-
Breakdown Torque	-	-	-	-
Full Load	-	-	-	-

Speed Torque Curve

Please contact Techtop for image.

Dimensional Drawing

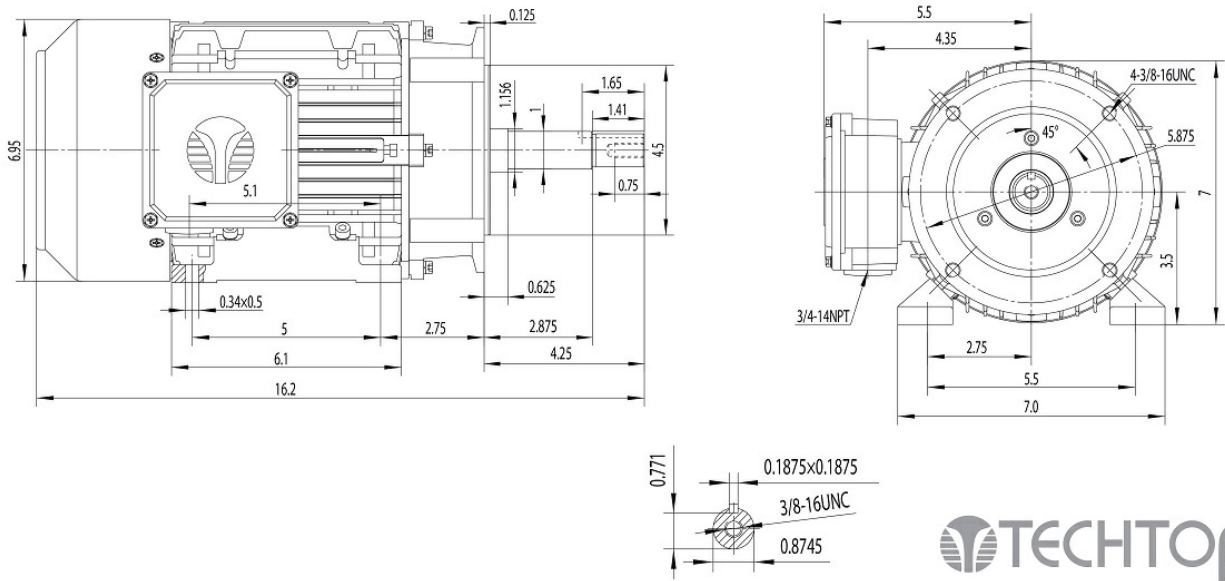

Dimensions are for reference only. Allowance should be made for minor deviations in non standard specified properties.

3D Image Link: Not available for this motor

