

## NEMA

<b>MOTOR MODEL:</b>	GA3-CI-TF-284JP-2-BR-D-25
<b>FACTORY TYPE:</b>	TFC

### EPAct NEMA Cast Iron, TEFC

ELECTRICAL DATA		
	60 Hz	50 Hz
Horsepower	25.0	25.0
Speed, RPM	3550	-
Voltage	230/460	-
# Phase	3	
Full Load Amps	57.8/28.9	-
Power Factor	0.9	-
Nominal Efficiency	91.0	-
3/4 Load Efficiency	-	-
Service Factor	1.25	-
KVA Code	F	-
FL Amps. @ 208 V	-	-
Locked Rotor Current	-	-
Start Capacitor	-	
Start Capacitor V	-	
Run Capacitor	-	
Run Capacitor V	-	
Number of Leads	12	
Connection	DD/D	
Coil Resistance	0.23	
Date Code	-	
Load	Efficiency %	P.F.
50%	-	-
75%	-	-
100%	-	-
FULL LOAD TEMPERATURE RISE		
FL Temp Rise °C	55.0	70.0
3D Image Link		
Not available for this motor		

GENERAL DATA		
Frame Size	284JP	
Frame Enclosure	TEFC	
Mounting	Rigid/C-Flange	
Insulation Class	F	
Duty	Cont. / S1	
NEMA Design	B	
Frame Material	Cast Iron	
Ingress Protection	55	
Tropicalization	true	
Cable Entry	1-NPT 1-1/2"	
Feet Removable	true	
Double Drilled	-	
Paint Color	Graphite Gray	
Paint RAL	7024	
Weight lb	353.0	
MECHANICAL DATA		
DE Bearing	6311 C3	
NDE Bearing	6311 C3	
dB No-Load	-	
Rotor Wk <sup>2</sup> , Lb-Ft <sup>2</sup>	1.73944	
Comp Ring (wavey washer)	NDE	
TORQUE VALUES		
	Torque lb-ft	% FLT
Locked Rotor Torque	-	-
Pull-Up Torque	-	-
Breakdown Torque	-	-
Full Load Torque	-	-
SITE CONDITIONS		
Ambient Temp °C	40	
Altitude Above Sea Level m	1000	

\*This report valid for above Date Code and newer models, please contact Techtop for more info.



## Pump Motors

# NEMA

<b>MOTOR MODEL:</b>	GA3-CI-TF-284JP-2-BR-D-25
<b>FACTORY TYPE:</b>	TFC

### EPAct NEMA Cast Iron, TEFC

Non Sinusoidal (VFD) Output 25.0HP, 3550 RPM

Torque Speed (T-n) Curve

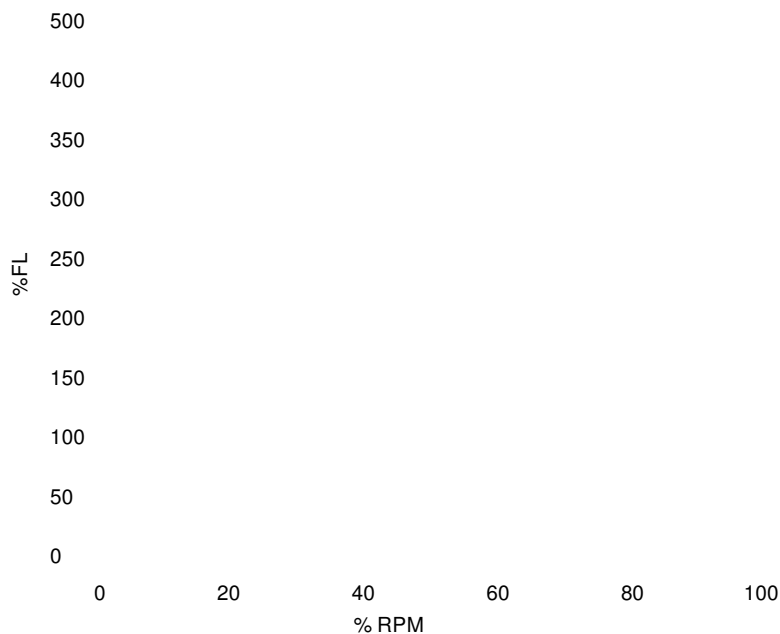

Performance Load Values, High Voltage, 60Hz

Torque Values	Torque lb-ft	% FLT	Performance Values
Locked Rotor Torque	-	-	Start Configuration
Pull-Up Torque	-	-	Starting Current (A)
Breakdown Torque	-	-	No-Load Current (A)
Full Load	-	-	No-Load Power Factor

% Load	Horsepower	Current, Amps	Input power, Kilowatts	Speed, RPM	Efficiency	PF
0	-	-	-	-	-	-
25	-	-	-	-	-	-
50	-	-	-	-	-	-
75	-	-	-	-	-	-
100	-	-	-	-	-	-
125	-	-	-	-	-	-

Techtop Industries  
 2815 Colonnades Court  
 Peachtree Corners, GA 30071  
 Tel: 678-436-5540  
 E-Mail: info@techttopind.com