

Techtop Industries Nameplate and Performance Data

NAMEPLATE DATA		
	60 Hz.	50 Hz.
Horsepower	2.0	2.0
Frame Size	145T	
Speed, RPM	1740	1425
Voltage	3 Phase US	190/380
# Phase	3	
Full Load Amps	5.58/2.79	6.64/3.32
Power Factor	0.78	-
Nominal Efficiency	86.5	83.5
3/4 Load Efficiency	-	-
Service Factor	1.25	1.0
Duty	Cont. / S1	
FL Temp Rise °C	-	27.0
Enclosure	TEFC	
Ambient Temp °C	40	
KVA Code	K	G
FL Amps. @ 208 V	5.95	-
Insulation Class	F	
NEMA Design	B	
Weight	39.5	
DE Bearing	6205ZZ	
NDE Bearing	6205ZZ	
dB No-Load	-	
Rotor Wk², Lb-Ft²	-	
Start Capacitor		
Start Capacitor V	-	
Run Capacitor		
Run Capacitor V	-	
Number of Leads	9	
Connection	YY/Y	
Coil Resistance	6.4	

Motor Model:	GR3-AL-TF-145T-4-B-D-2
---------------------	-------------------------------

Performance Load Values:

% Load	Horsepower	Current, Amps	Input power, Kilowatts	Speed, RPM	Efficiency	PF
0	-	-	-	-	-	-
25	-	-	-	-	-	-
50	-	-	-	-	-	-
75	-	-	-	-	-	-
100	-	-	-	-	-	-
125	-	-	-	-	-	-
150	-	-	-	-	-	-
SF	-	-	-	-	-	-

	Torque, Lb-Ft	% Full Load Torque	Speed, RPM	Current Amps.
Locked Rotor Torque	-	-	-	-
Pull Up Torque	-	-	-	-
Breakdown Torque	-	-	-	-
Full Load	-	-	-	-

Speed Torque Curve

Please contact Techtop for image.

Dimensional Drawing

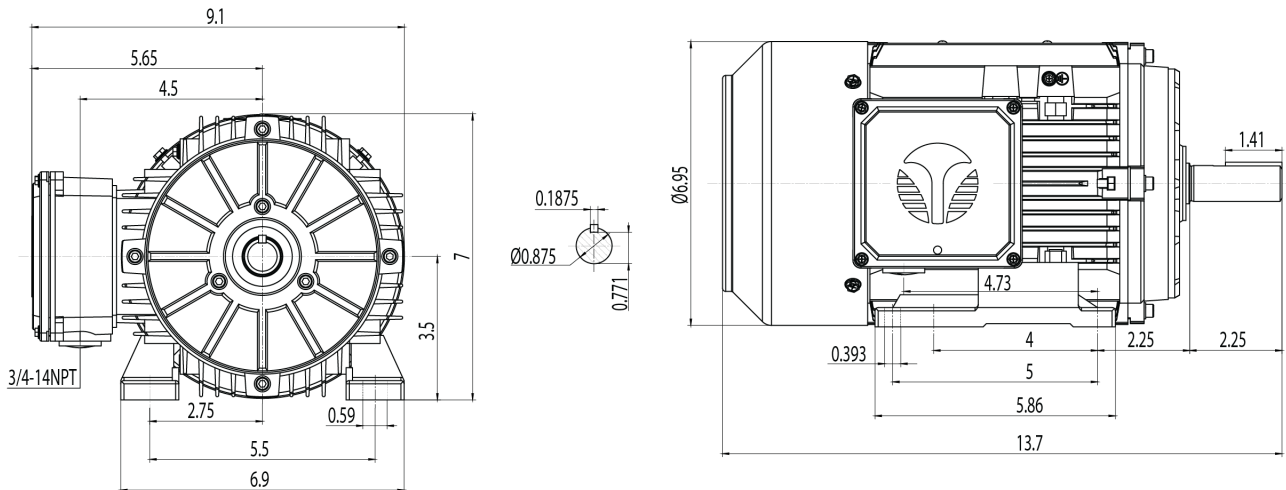

Dimensions are for reference only. Allowance should be made for minor deviations in non standard specified properties.

3D Image Link: Not available for this motor