

Techtop Industries Nameplate and Performance Data

NAMEPLATE DATA		
	60 Hz.	50 Hz.
Horsepower	50.0	50.0
Frame Size	250M	
Speed, RPM	1180	-
Voltage	3 Phase US (575V)	-
# Phase	3	
Full Load Amps	47.36	-
Power Factor	0.84	-
Nominal Efficiency	94.1	-
3/4 Load Efficiency	-	-
Service Factor	1.15	1.0
Duty	Cont. / S1	
FL Temp Rise °C	60.0	-
Enclosure	TEFC	
Ambient Temp °C	40	
KVA Code	H	-
FL Amps. @ 208 V	-	-
Insulation Class	F	
NEMA Design	-	
Weight	772.0	
DE Bearing	6314C3	
NDE Bearing	6314C3	
dB No-Load	-	
Rotor Wk ² , Lb-Ft ²	-	
Start Capacitor		
Start Capacitor V		
Run Capacitor		
Run Capacitor V		
Number of Leads	6	
Connection	?	
Coil Resistance	-	

Motor Model:	GR3-CI-TF-250MB3-6-BR-F-50
---------------------	-----------------------------------

Performance Load Values:

% Load	Horsepower	Current, Amps	Input power, Kilowatts	Speed, RPM	Efficiency	PF
0	-	-	-	-	-	-
25	-	-	-	-	-	-
50	-	-	-	-	-	-
75	-	-	-	-	-	-
100	-	-	-	-	-	-
125	-	-	-	-	-	-
150	-	-	-	-	-	-
SF	-	-	-	-	-	-

	Torque, Lb-Ft	% Full Load Torque	Speed, RPM	Current Amps.
Locked Rotor Torque	-	-	-	-
Pull Up Torque	-	-	-	-
Breakdown Torque	-	-	-	-
Full Load	-	-	-	-

Speed Torque Curve

Please contact Techtop for image.

Dimensional Drawing

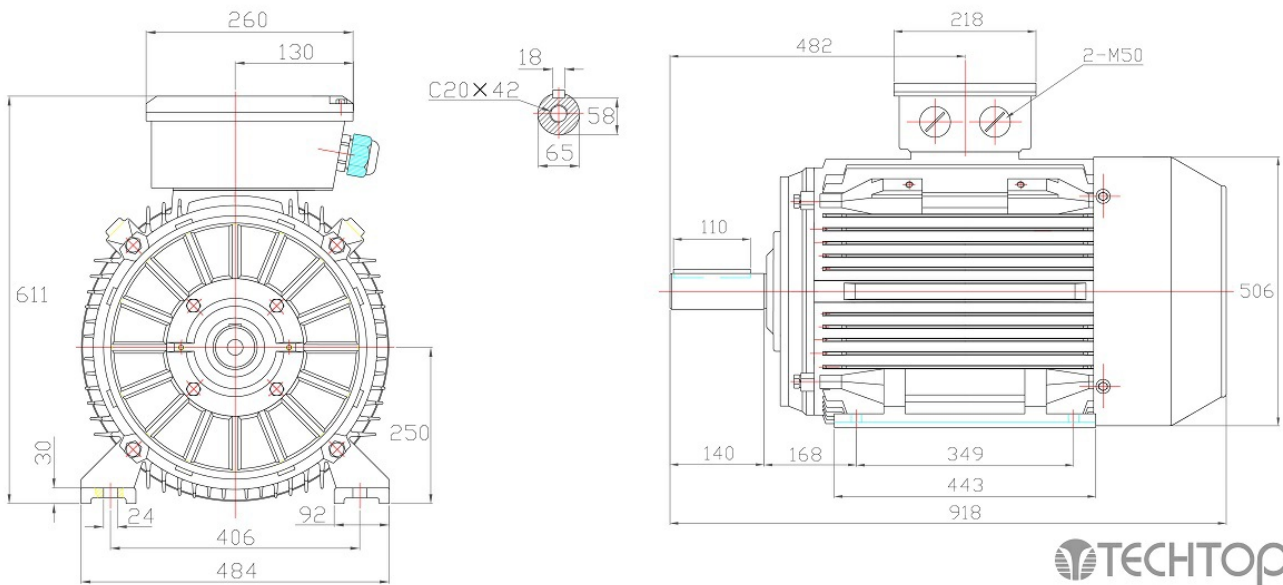

Dimensions are for reference only. Allowance should be made for minor deviations in non standard specified properties.

3D Image Link: Not available for this motor

